

H 172

Part No.: 7214063

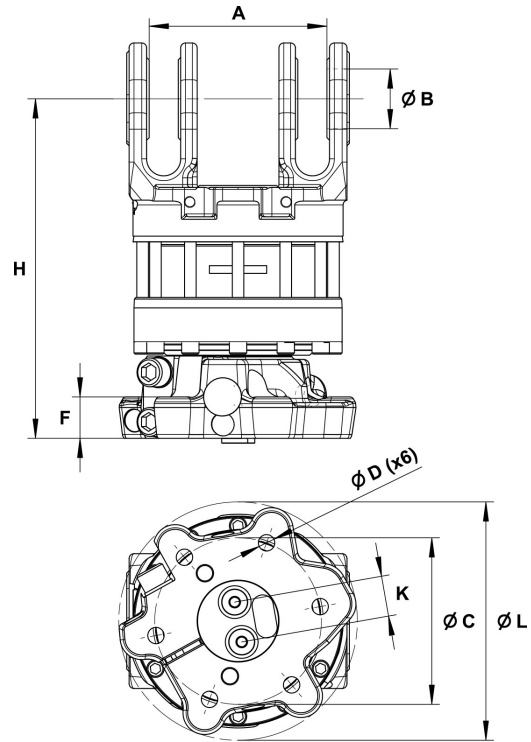
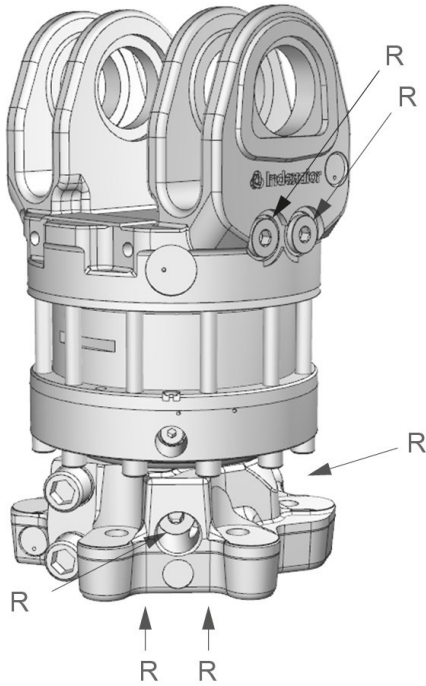

Upper connection	Lower connection
G 1/2	G 1/2

A: MPB2	B: MPB	C: Ø173 mm	D: Ø17 mm	F: 40 mm	H: 352 mm	K: 42 mm	L: Ø248 mm
------------	-----------	---------------	--------------	-------------	--------------	-------------	---------------

		Max 	Max 		Max 	Max 
62.9 kg	360°	160 kN	50 kN	3300 Nm	35 l/min	25 MPa

Rotator suitable for MPB swing dampers.

Adapter sets are available for alternative connections.

For further technical information relating to integration and hydraulic connections, please contact rotator@indexator.com