

# GV 17US

Part No.: 5217180

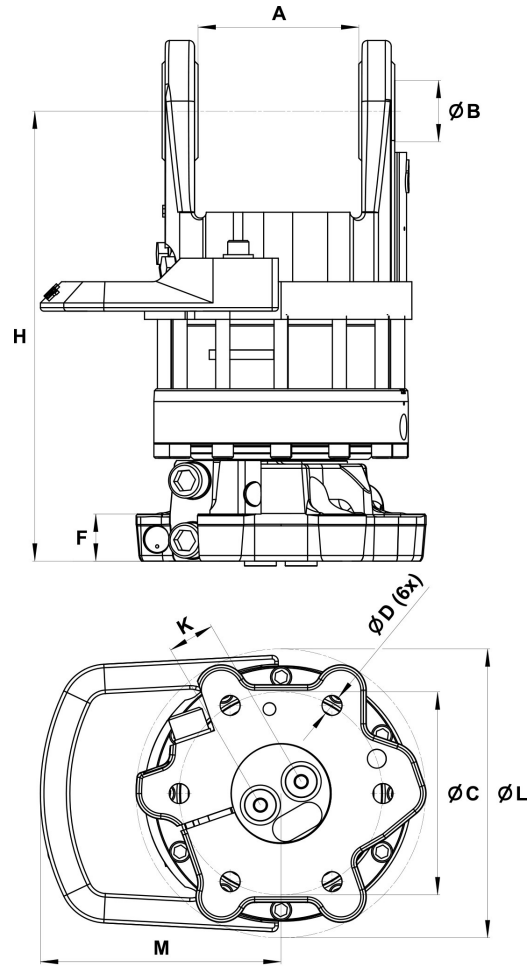
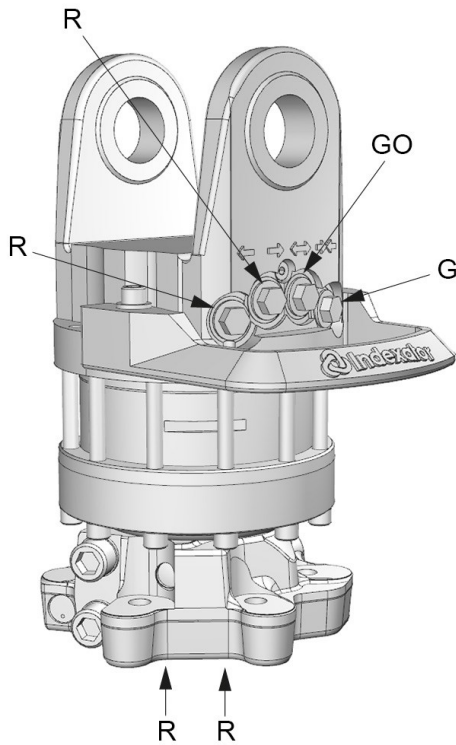

Upper connection	Lower connection
7/8"-14 UNF	G 1/2

A: 136,5 mm	B: Ø52,2 mm	C: Ø173 mm	D: Ø17 mm	F: 40 mm	H: 381 mm	K: 40 mm	L: Ø248 mm	M: 202 mm
----------------	----------------	---------------	--------------	-------------	--------------	-------------	---------------	--------------

		Max 	Max 		Max 	Max 	Max 	Max 
69.5 kg	360°	160 kN	50 kN	3300 Nm	35 l/min	25 MPa	25 MPa	25 MPa

For further technical information relating to integration and hydraulic connections, please contact [rotator@indexator.com](mailto:rotator@indexator.com)